

H15R Core

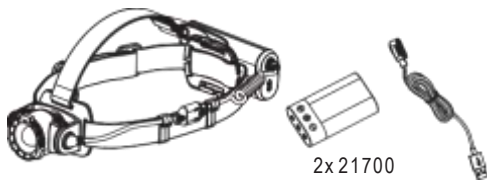

H15R Work

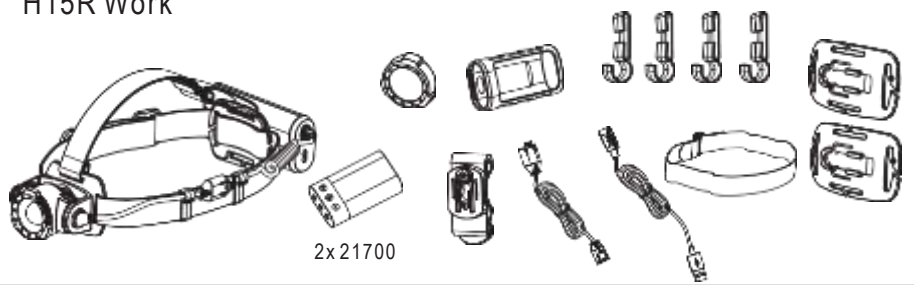

Battery Replacement

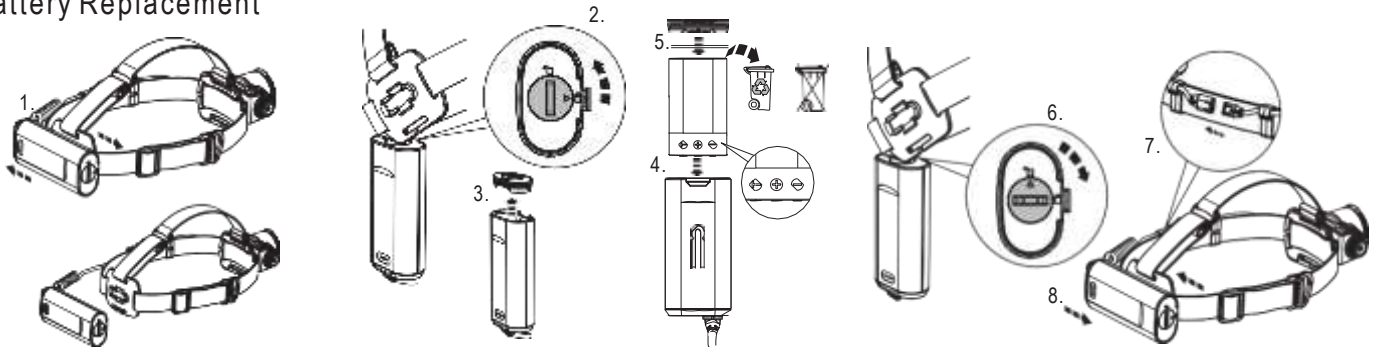

Operation

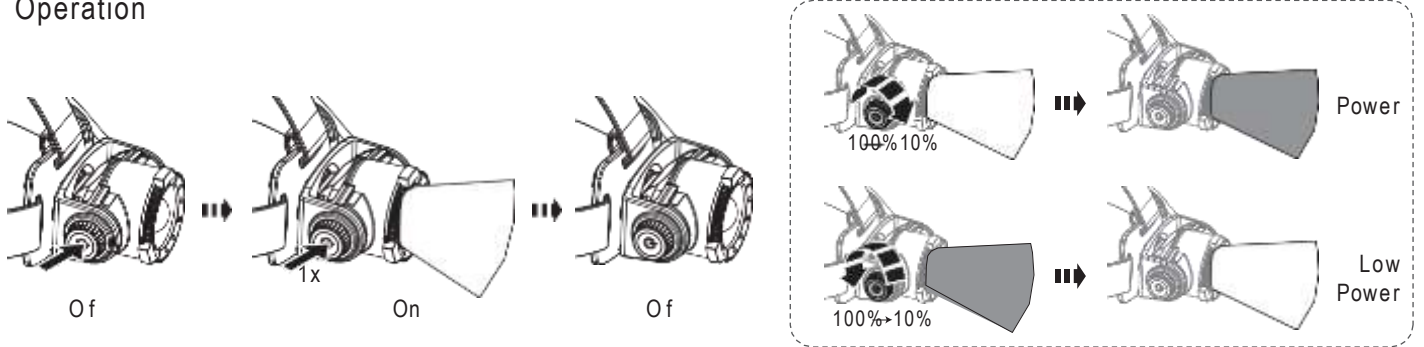

Transportation Lock

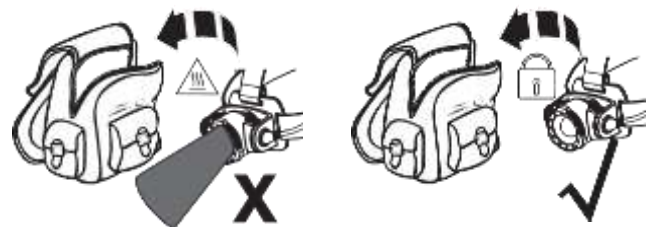
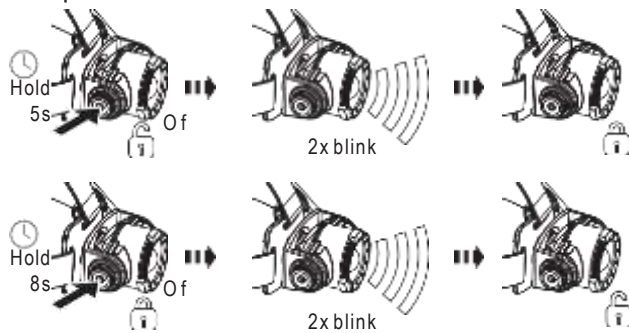

App Mode

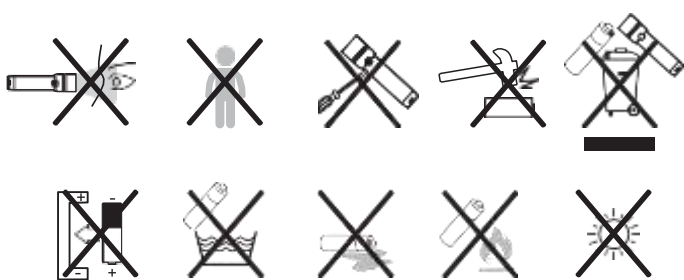
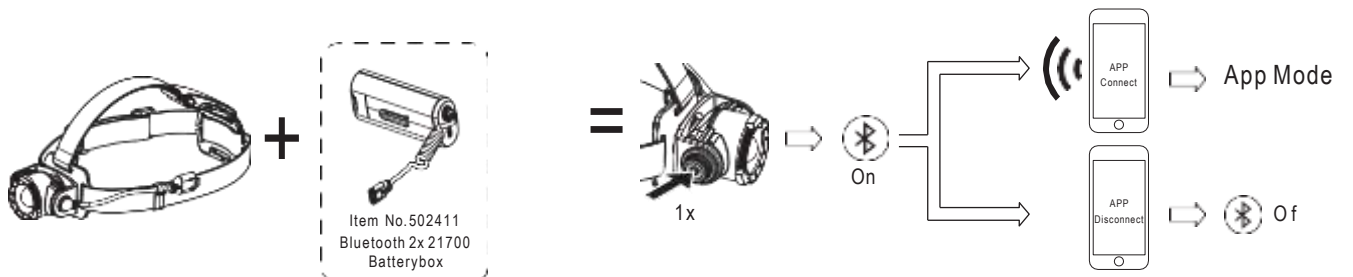

Ledlenser GmbH & Co. KG
 Kronenstr. 5-7 • 42699 Solingen • Germany
 Phone +49 212/5948-0 Fax +49 212/5948-200
info@ledlenser.com



ledlenser.com



H15R_V.01
 10.06.2020
 1J12A0842

Battery Indicator

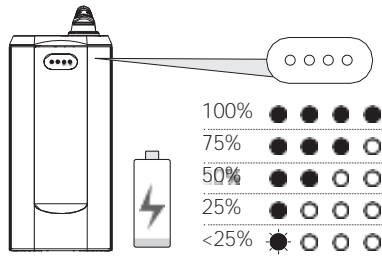

Backup Mode

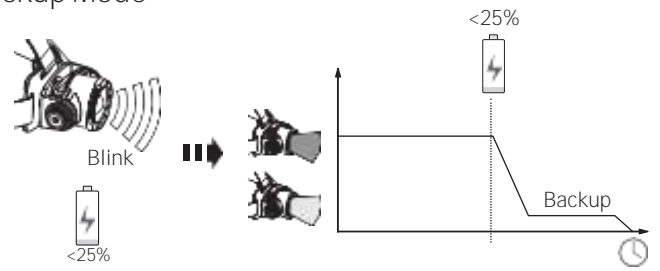

Magnetic Charging System

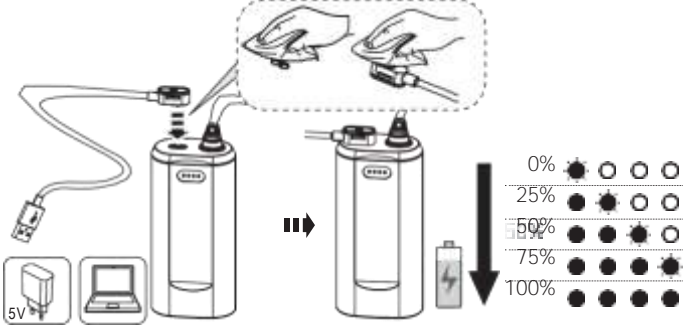

Lamp Head Rotation

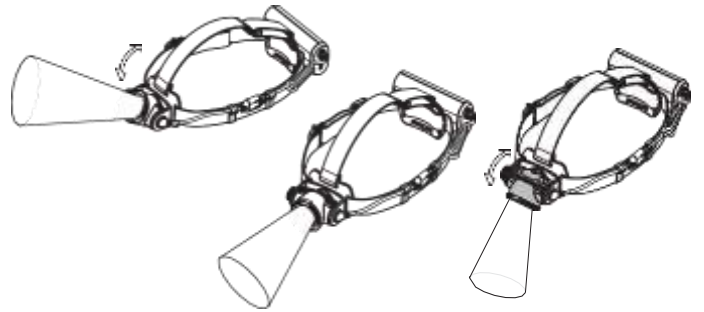

Advanced Focus System

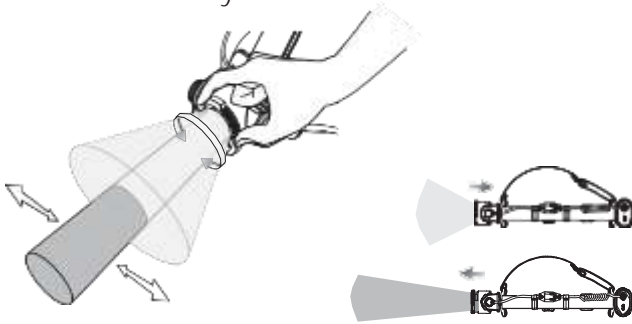

Boost

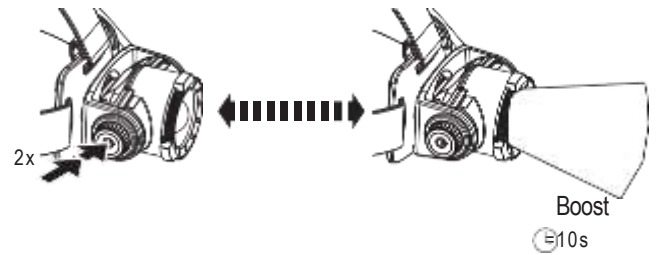

Protective Covers (H15R Work)

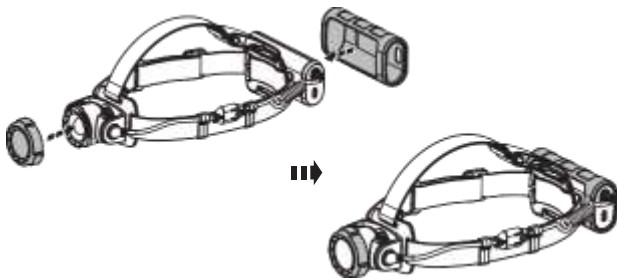

Extension Cable (H15R Work)

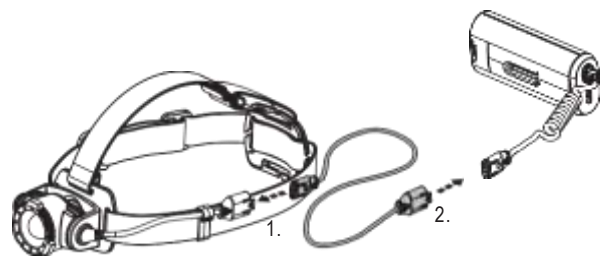

Belt Clip (H15R Work)

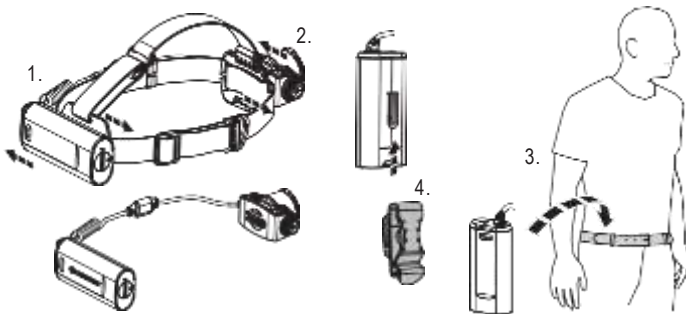

Transparent Silicone Helmet Band (H15R Work)

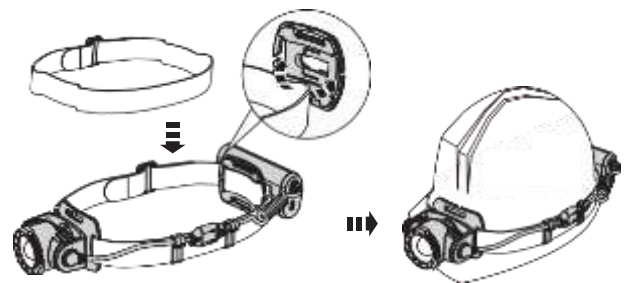

Helmet Fixing Clips (H15R Work)

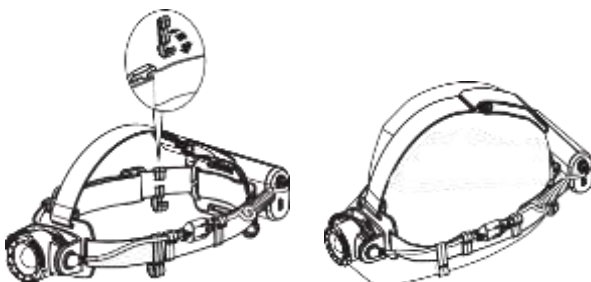

Further Information

